



FAG

S2BCF-190MM-HD [↗](#)

Узел стационарного корпуса

Фланцевый корпус



Техническая информация

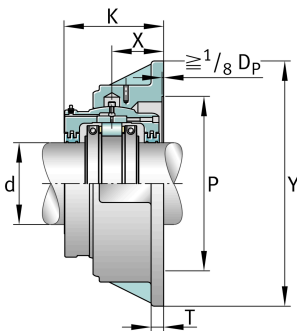
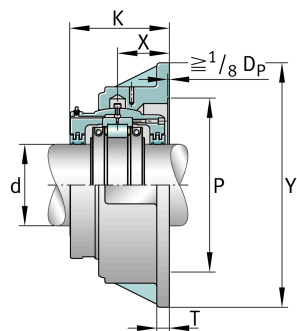

Основные размеры и рабочие характеристики

| | | |
|----|------------|-------------------------|
| d | 190 mm | Shaft diameter |
| Y | 647,7 mm | Flange outside diameter |
| K | 263,525 mm | Width |
| ≈m | 319,329 kg | Вес |

Габаритные размеры

| | | |
|---|----------------|-----------------------------|
| | S2BCF-190MM-HD | Complete unit held |
| | S2BCF-190MM-FL | Complete unit float |
| | FH-24 | Housing designation |
| X | 136,525 mm | Bearing centerline location |
| Z | 571,5 mm | Bolt circle diameter |
| S | 401,637 mm | Bolt hole distance |
| T | 31,75 mm | Thickness of flange |
| P | 492,125 mm | Pilot counterbore diameter |
| S | 4 | # of Mounting Bolts |
| S | 31,75 mm | Mounting bolt diameter |