

**FAG****S2BCF-508-HD**

Узел стационарного корпуса

Фланцевый корпус

Техническая информация

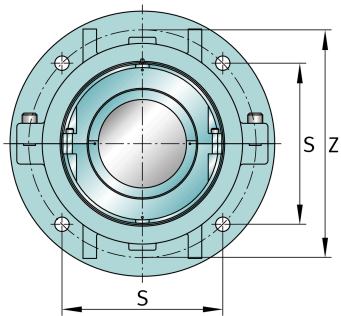

Основные размеры и рабочие характеристики

d	139,7 mm	Shaft diameter
Y	508 mm	Flange outside diameter
K	207,962 mm	Width
≈m	131,542 kg	Вес

Габаритные размеры

	S2BCF-508-HD	Complete unit held
	S2BCF-508-FL	Complete unit float
	FH-20	Housing designation
X	111,125 mm	Bearing centerline location
Z	444,5 mm	Bolt circle diameter
S	314,325 mm	Bolt hole distance
T	25,4 mm	Thickness of flange
P	377,825 mm	Pilot counterbore diameter
S	4	# of Mounting Bolts
S	25,4 mm	Mounting bolt diameter