



FAG

S1BCF-1600-FL [↗](#)

Узел стационарного корпуса

Фланцевый корпус

Техническая информация

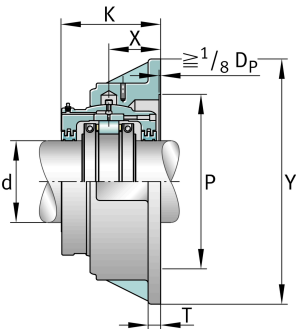
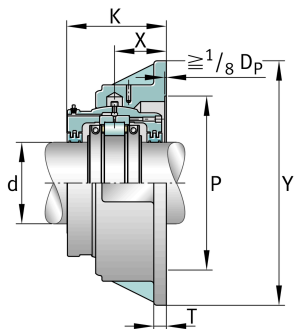
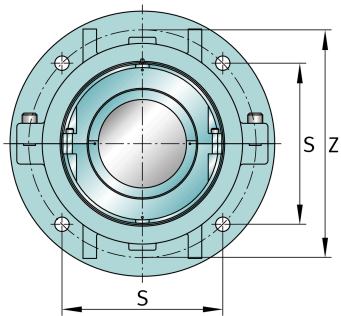

Основные размеры и рабочие характеристики

d	406,4 mm	Shaft diameter
Y	914,4 mm	Flange outside diameter
K	307,975 mm	Width
≈m	503,487 kg	Вес

Габаритные размеры

S1BCF-1600-HD	Complete unit held	
S1BCF-1600-FL	Complete unit float	
FH-116	Housing designation	
X	165,1 mm	Bearing centerline location
Z	800,1 mm	Bolt circle diameter
S	565,944 mm	Bolt hole distance
T	44,45 mm	Thickness of flange
P	673,1 mm	Pilot counterbore diameter
S	8	# of Mounting Bolts
S	31,75 mm	Mounting bolt diameter