



FAG

S1BCF-700-FL [↗](#)

Узел стационарного корпуса

Фланцевый корпус



Техническая информация

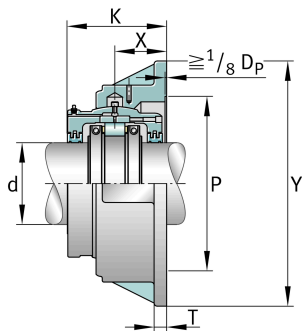
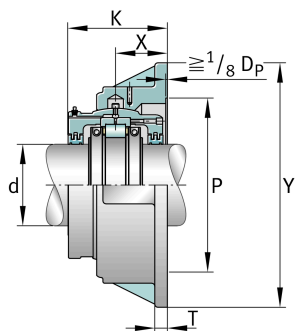

Основные размеры и рабочие характеристики

d	177,8 mm	Shaft diameter
Y	508 mm	Flange outside diameter
K	207,962 mm	Width
≈m	120,202 kg	Вес

Габаритные размеры

	S1BCF-700-HD	Complete unit held
	S1BCF-700-FL	Complete unit float
	FH-12	Housing designation
X	107,95 mm	Bearing centerline location
Z	438,15 mm	Bolt circle diameter
S	309,563 mm	Bolt hole distance
T	28,575 mm	Thickness of flange
P	365,125 mm	Pilot counterbore diameter
S	4	# of Mounting Bolts
S	25,4 mm	Mounting bolt diameter