



FAG

S1BCF-303-FL [↗](#)

Узел стационарного корпуса

Фланцевый корпус

Техническая информация

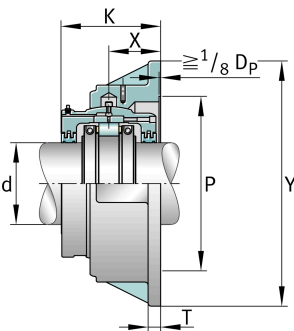
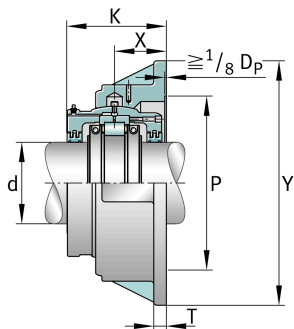
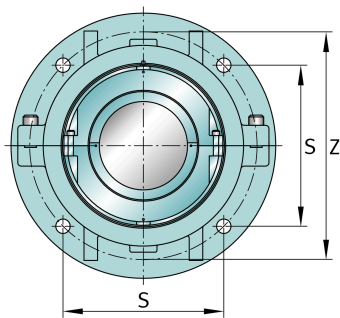

Основные размеры и рабочие характеристики

d	80,962 mm	Shaft diameter
Y	330,2 mm	Flange outside diameter
K	147,637 mm	Width
≈m	36,287 kg	Вес

Габаритные размеры

	S1BCF-303-HD	Complete unit held
	S1BCF-303-FL	Complete unit float
	FH-5	Housing designation
X	79,375 mm	Bearing centerline location
Z	273,05 mm	Bolt circle diameter
S	193,675 mm	Bolt hole distance
T	19,05 mm	Thickness of flange
P	215,9 mm	Pilot counterbore diameter
S	4	# of Mounting Bolts
S	12,7 mm	Mounting bolt diameter