



FAG

S1BCF-150MM-HD [↗](#)

Узел стационарного корпуса

Фланцевый корпус

Техническая информация

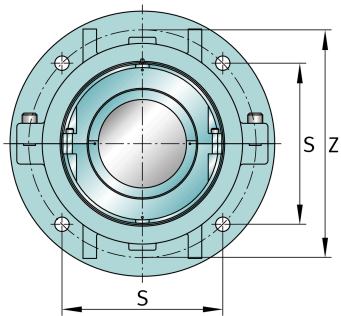

Основные размеры и рабочие характеристики

d	150 mm	Shaft diameter
Y	469,9 mm	Flange outside diameter
K	201,612 mm	Width
≈m	97,522 kg	Вес

Габаритные размеры

S1BCF-150MM-HD	Complete unit held
S1BCF-150MM-FL	Complete unit float
FH-10	Housing designation
X	114,3 mm Bearing centerline location
Z	412,75 mm Bolt circle diameter
S	292,1 mm Bolt hole distance
T	25,4 mm Thickness of flange
P	346,075 mm Pilot counterbore diameter
S	4 # of Mounting Bolts
S	25,4 mm Mounting bolt diameter