

**FAG****S1BCF-515-HD**

Узел стационарного корпуса

Фланцевый корпус



Техническая информация

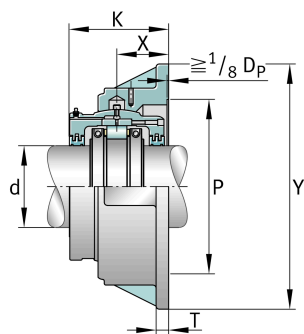

Основные размеры и рабочие характеристики

d	150,813 mm	Shaft diameter
Y	469,9 mm	Flange outside diameter
K	201,612 mm	Width
≈m	97,522 kg	Вес

Габаритные размеры

S1BCF-515-HD	Complete unit held	
S1BCF-515-FL	Complete unit float	
FH-10	Housing designation	
X	114,3 mm	Bearing centerline location
Z	412,75 mm	Bolt circle diameter
S	292,1 mm	Bolt hole distance
T	25,4 mm	Thickness of flange
P	346,075 mm	Pilot counterbore diameter
S	4	# of Mounting Bolts
S	25,4 mm	Mounting bolt diameter