



FAG

S1BCF-100MM-HD [↗](#)

Узел стационарного корпуса

Фланцевый корпус



Техническая информация

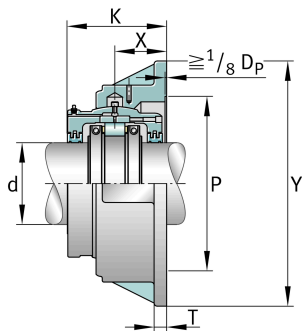
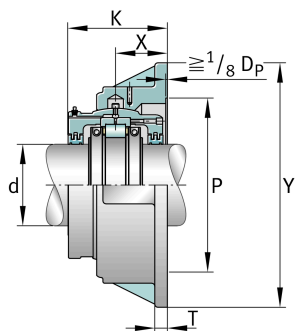

Основные размеры и рабочие характеристики

d	100 mm	Shaft diameter
Y	355,6 mm	Flange outside diameter
K	152,4 mm	Width
≈m	42,638 kg	Вес

Габаритные размеры

	S1BCF-100MM-HD	Complete unit held
	S1BCF-100MM-FL	Complete unit float
	FH-6	Housing designation
X	85,725 mm	Bearing centerline location
Z	301,625 mm	Bolt circle diameter
S	212,725 mm	Bolt hole distance
T	19,05 mm	Thickness of flange
P	244,475 mm	Pilot counterbore diameter
S	4	# of Mounting Bolts
S	15,875 mm	Mounting bolt diameter