



FAG

S1BCF-204-HD

Узел стационарного корпуса

Фланцевый корпус



Техническая информация

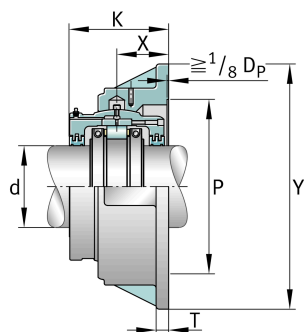

Основные размеры и рабочие характеристики

d	57,15 mm	Shaft diameter
Y	260,35 mm	Flange outside diameter
K	119,063 mm	Width
≈m	16,783 kg	Вес

Габаритные размеры

S1BCF-204-HD	Complete unit held	
S1BCF-204-FL	Complete unit float	
FH-3	Housing designation	
X	66,675 mm	Bearing centerline location
Z	217,487 mm	Bolt circle diameter
S	153,987 mm	Bolt hole distance
T	15,875 mm	Thickness of flange
P	166,688 mm	Pilot counterbore diameter
S	4	# of Mounting Bolts
S	12,7 mm	Mounting bolt diameter