



FAG

S1BCH-90MM-FL-2B [↗](#)

Узел стационарного корпуса

FAG split cylindrical roller bearing housing

Техническая информация



Основные размеры и рабочие характеристики

d	90 mm	Shaft diameter
B	381 mm	Length base
H	255,587 mm	Housing height
≈m	26,308 kg	Bec



Габаритные размеры

	S1BCH-90MM-FL-2B	Complete unit float
	S1BCH-90MM-HD-2B	Complete unit held
	PH-5-2B	Housing designation
A	111,919 mm	Center height
C	88,9 mm	Base width
D	44,45 mm	Base height
E _{min}	309,563 mm	Base hole distance 1 min
E _{max}	334,962 mm	Base hole distance 1 max
S	2	# of mounting bolts
S	19,05 mm	Mounting bolt diameter
	S1BC-90MM-FL	Cartridge float bearing
	S1BC-90MM-HD	Cartridge held bearing
	S1C-308	Cartridge
G	131,762 mm	Length through bore
L	177,8 mm	Outside diameter cartridge
	297,602 kg	Grease capacity
	11,567 kg	Cartridge weight
	S1B-90MM-FL	Bearing float
	S1B-90MM-HD	Bearing held
	4,173 kg	Bearing weight
	308 Grp	Housing group
C _r	165.914,848 N	Динамическая грузоподъемность, радиальная
C _{0r}	233.057,408 N	Статическая грузоподъемность, радиальная
C _a	2.001,6 N	Динамическая грузоподъемность, осевая
	2.740 1/min	Limiting speed
D ₀	152,4 mm	Outside diameter bearing
C ₀	70,637 mm	Width inner ring
B ₀	38,887 mm	Width outer ring

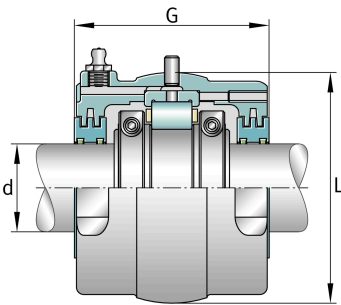
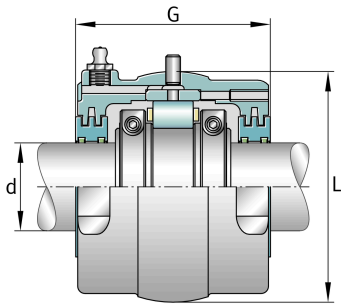
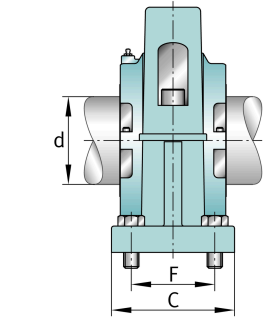



Просмотреть сведения о продукте на medias

10.06.2026, 10:37:27 UTC

SCHAEFFLER

