



LS4565

Bearing washer

Bearing washers, suitable for AXK and K811

Technical information



Main Dimensions & Performance Data

d	45 mm	Bore diameter track washer
D	65 mm	Outside diameter track washer
B	4 mm	Width
	45 °	Chamfer Angle
a min	1 mm	Chamfer width
≈m	50,1 g	Weight

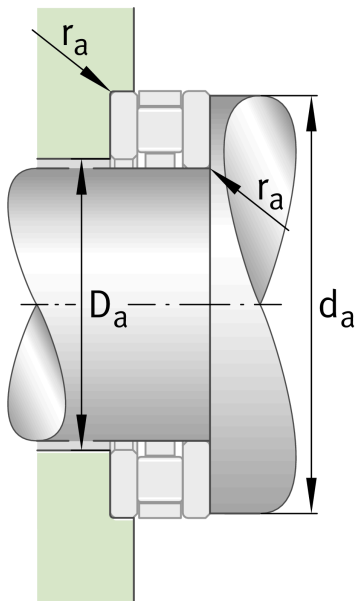



View product details on medias

26.06.2026, 20:25:05 KST

SCHAEFFLER

