

LS140180

Bearing washer

Bearing washers, suitable for AXK and K811

Technical information

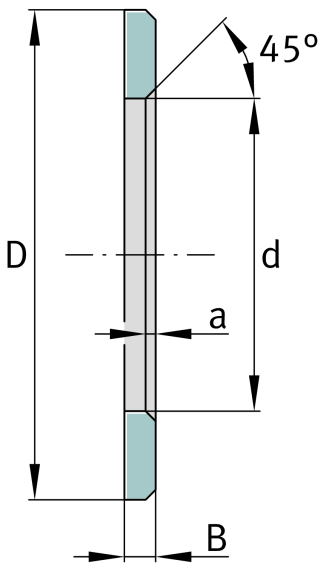

Main Dimensions & Performance Data

d	140 mm	Bore diameter track washer
D	180 mm	Outside diameter track washer
B	9,5 mm	Width
	45 °	Chamfer Angle
a min	1,5 mm	Chamfer width
≈m	0,749 kg	Weight





View product details on medias

26.06.2026, 22:56:23 KST

SCHAEFFLER

