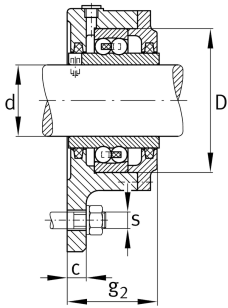
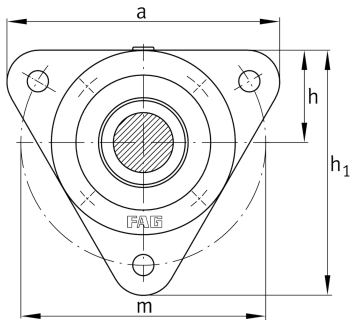

**FAG****F11208** [↗](#)

## Flanged housing

Flanged housing for self-aligning ball bearing  
112 with wide inner-ring, felt seal, grease  
lubrication

## Technical information

**Main Dimensions & Performance Data**

d	40 mm	Shaft diameter
a	160 mm	Flange width
g <sub>2</sub>	60 mm	Total width with cover
h <sub>1</sub>	143 mm	Height flange
≈m	2,2 kg	Weight

**Dimensions**

	M10x1	Connection thread for lubrication
c	12 mm	Thickness of flange
D	80 mm	Outside diameter bearing
h	54 mm	Distance shaft axis
m	140 mm	Pitch circle diameter fixing holes
s	M12	Size of fixing screws

**Temperature range**

T <sub>min</sub>	-20 °C	Operating temperature min.
T <sub>max</sub>	100 °C	Operating temperature max.