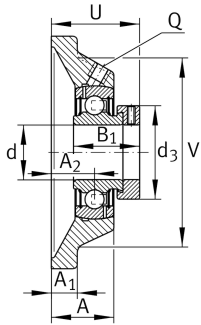
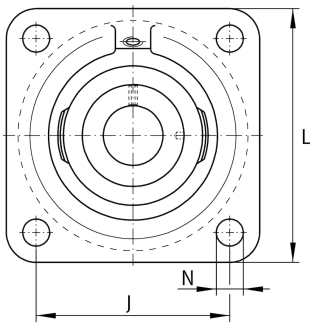

IMAGE
COMING SOON**PCJ30-TV-FA125.5** [↗](#)

Flanged housing unit

Flanged housing unit PCJ...-TV

Technical information

**Your current product variant**

Material	TV	Plastic
Manufacturing instruction	FA125.5	Bearing with Corroprotect coating

Main Dimensions & Performance Data

d	30 mm	Bore diameter
L	107 mm	Flange width
U	46 mm	Total height unit
C _r	17.100 N	Basic dynamic load rating, radial
C _{0r}	9.200 N	Basic static load rating, radial
C _{0r G}	17.700 N	Load carrying capacity (housing)
≈m	0,57 kg	Weight

Mounting dimensions

J	83 mm	Distance fixing bore
N	11 mm	Fixing bore
n	4	Number of screwing holes



Dimensions

A	31,5 mm	Height housing
A ₁	14,3 mm	Thickness of flange
A ₂	19,2 mm	Distance raceway
V	80 mm	Shoulder diameter housing
Q	1/4-28 UNF	Connection thread for lubrication
d ₃	44 mm	Outside diameter locking device

Additional information

1	Number of housings
GEH.CJ06-TV-HLA	Housing
GRAE30-NPP-B-FA107/125.5	Bearing designation
KASK06	Protecting cap

Temperature range

T _{min}	-35 °C	Operating temperature min.
T _{max}	100 °C	Operating temperature max.