

**NKXR20-Z-XL**

Needle roller/axial cylindrical roller bearing

Needle roller/axial cylindrical roller bearings
NKXR...-Z, axial component, single direction,
to DIN 5429, with end cap, for grease
lubrication

X-life

Technical information

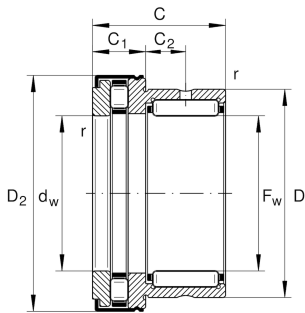
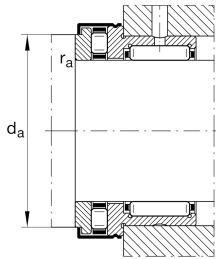

Your current product variant

Sealing	Z	Bearing with end cap
Tolerance class	PN	Normal (DIN 620-2)

Main Dimensions & Performance Data

F_w	20 mm	Bore diameter
D	30 mm	Outside diameter
C	30 mm	Height
C_r	18.600 N	Basic dynamic load rating, radial
C_{0r}	23.800 N	Basic static load rating, radial
C_a	25.000 N	Basic dynamic load rating, axial
C_{0a}	53.000 N	Basic static load rating, axial
C_{ur}	4.200 N	Fatigue load limit, radial
C_{ua}	7.500 N	Fatigue load limit, axial
n_G	10.000 1/min	Limiting speed
n_{gr}	4.200 1/min	Reference speed
$\approx m$	84,04 g	Weight

Mounting dimensions

d_a	30,7 mm	Mounting dimension shaft shoulder
$r_{a \max}$	0,3 mm	Maximum recess radius



Dimensions

D 2 max	36,2 mm	Maximum outside diameter flange
C 1	10 mm	Width of the axial bearing component
C 2	10,5 mm	Distance to lubrication hole
d _w	20 mm	Bore diameter of shaft washer
r _{min}	0,3 mm	Minimum chamfer dimension

Temperature range

T _{min}	-30 °C	Operating temperature min.
T _{max}	120 °C	Operating temperature max.

Additional information

IR17X20X20-XL	Suitable inner rings IR
---------------	-------------------------

Characteristics

-  Radial load
-  Axial load in one direction
-  Grease Lubrication
-  Sealed on one side