

**NX12-XL**

Needle roller/axial ball bearing

Needle roller/axial ball bearings NX, single direction axial component, for oil lubrication

X-life

Technical information

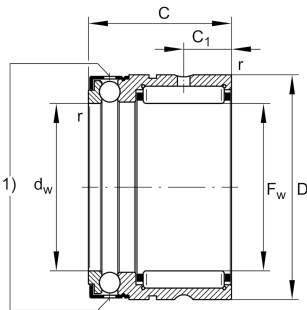
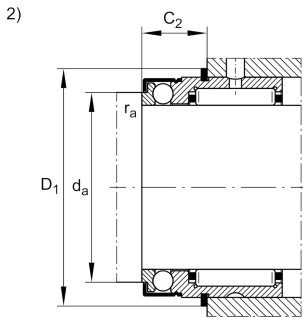

Your current product variant

Type of Seal	Without
Cage	Standard

Main Dimensions & Performance Data

F_w	12 mm	Bore diameter
D	21 mm	Outside diameter
C	18 mm	Height
C_r	5.400 N	Basic dynamic load rating, radial
C_{0r}	4.300 N	Basic static load rating, radial
C_a	4.850 N	Basic dynamic load rating, axial
C_{0a}	8.200 N	Basic static load rating, axial
C_{ur}	840 N	Fatigue load limit, radial
C_{ua}	375 N	Fatigue load limit, axial
n_G	9.500 1/min	Limiting speed
$\approx m$	23,44 g	Weight



Mounting dimensions

d_a	16,6 mm	Mounting dimension shaft shoulder
$r_{a \max}$	0,3 mm	Maximum recess radius
D_1	23,7 mm	Connection diameter snap ring
C_2	10 mm	Connection width with snap ring

Dimensions

C_1	4,7 mm	Distance to lubrication hole
C_2	4,7 mm	Distance to lubrication hole
d_w	12 mm	Bore diameter of shaft washer
r_{\min}	0,3 mm	Minimum chamfer dimension





Temperature range

T_{\min}	-30 °C	Operating temperature min.
T_{\max}	120 °C	Operating temperature max.

Additional information

IR8X12X10-IS1-XL	Suitable inner rings IR
WR21, SW21	Snap ring

Characteristics

	Radial load
	Axial load in one direction
	Grease Lubrication
	Oil Lubrication
	Not sealed