

**FAG****29334-E1-XL**

Axial spherical roller bearing

Axial spherical roller bearing 293..-E1-XL, no flanging ring

**X-life**

## Technical information

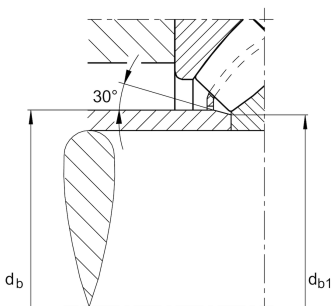
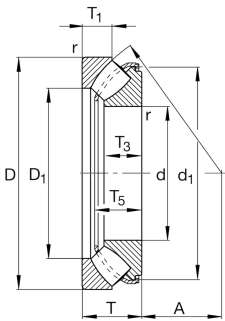

## Your current product variant

Heat treatment	Standard	Standard
Locating feature, housing washer	Without	
Cage	JP	Sheet metal cage
Handling thread holes	Without	
Constricted width and inclination variation	Standard	
Test certificate	Without	

## Main Dimensions &amp; Performance Data

d	170 mm	Bore diameter
D	280 mm	Outside diameter
T	67 mm	Height
C <sub>a</sub>	1.230.000 N	Basic dynamic load rating, axial
C <sub>0a</sub>	3.500.000 N	Basic static load rating, axial
C <sub>ua</sub>	455.000 N	Fatigue load limit, axial
n <sub>G</sub>	2.390 1/min	Limiting speed
n <sub>gr</sub>	1.260 1/min	Reference speed
≈m	14,363 kg	Weight



### Mounting dimensions

$d_{a \min}$	220 mm	Minimum diameter shaft shoulder
$D_{a \max}$	247 mm	Maximum diameter of housing shoulder
$D_{b \min}$	284 mm	Minimum bore diameter housing
$d_{b \max}$	188 mm	Maximum distance sleeve
$d_{b1 \max}$	180 mm	Maximum chamfer diameter of distance sleeve
$r_{a \max}$	2,5 mm	Maximum recess radius
	30 °	Angle of chamfer of the distance sleeve

### Dimensions

$D_1$	215 mm	Bore diameter housing washer
$d_1$	255,7 mm	Rip diameter shaft washer
$r_{\min}$	3 mm	Minimum chamfer dimension
$T_1$	30,5 mm	Height of the housing washer
$T_3$	42,2 mm	Height of the shaft washer
$T_5$	60,5 mm	Distance shaft washer - cage
A	96 mm	Distance of the center point







### Temperature range

$T_{\min}$	-30 °C	Operating temperature min.
$T_{\max}$	200 °C	Operating temperature max.



### Characteristics

---

-  Radial load
-  Axial load in one direction
-  Grease Lubrication
-  Oil Lubrication
-  Not sealed
-  Static angular error and misalignment
-  Dynamic angular error and misalignment