



FAG

29330-E1-XL

Axial spherical roller bearing

Axial spherical roller bearing 293..-E1-XL, no flanging ring

X-life

Technical information

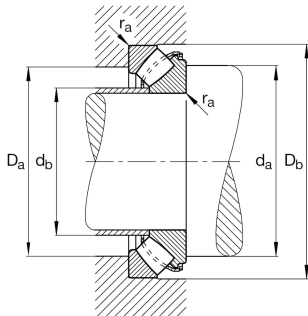

Your current product variant

Heat treatment	Standard	Standard
Locating feature, housing washer	Without	
Cage	JP	Sheet metal cage
Handling thread holes	Without	
Constricted width and inclination variation	Standard	
Test certificate	Without	

Main Dimensions & Performance Data

d	150 mm	Bore diameter
D	250 mm	Outside diameter
T	60 mm	Height
C _a	1.020.000 N	Basic dynamic load rating, axial
C _{0a}	2.900.000 N	Basic static load rating, axial
C _{ua}	385.000 N	Fatigue load limit, axial
n _G	2.750 1/min	Limiting speed
n _{gr}	1.400 1/min	Reference speed
≈m	10,22 kg	Weight



Mounting dimensions

$d_{a \min}$	195 mm	Minimum diameter shaft shoulder
$D_{a \max}$	220 mm	Maximum diameter of housing shoulder
$D_{b \min}$	254 mm	Minimum bore diameter housing
$d_{b \max}$	163 mm	Maximum distance sleeve
$d_{b1 \max}$	159 mm	Maximum chamfer diameter of distance sleeve
$r_{a \max}$	2,1 mm	Maximum recess radius
	30 °	Angle of chamfer of the distance sleeve

Dimensions







D_1	190 mm	Bore diameter housing washer
d_1	228,4 mm	Rip diameter shaft washer
r_{\min}	2,1 mm	Minimum chamfer dimension
T_1	28 mm	Height of the housing washer
T_3	38 mm	Height of the shaft washer
T_5	54,5 mm	Distance shaft washer - cage
A	87 mm	Distance of the center point

Temperature range

T_{\min}	-30 °C	Operating temperature min.
T_{\max}	200 °C	Operating temperature max.



Characteristics

-  Radial load
-  Axial load in one direction
-  Grease Lubrication
-  Oil Lubrication
-  Not sealed
-  Static angular error and misalignment
-  Dynamic angular error and misalignment