**FAG****NN3096-AS-K-M-SP**

Cylindrical roller bearing

Super precision cylindrical roller bearings
 NN30..-AS-K-M-SP, non-locating bearing,
 double row, with tapered bore, taper 1:12,
 separable, with cage

Technical information

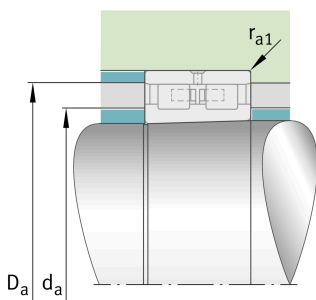
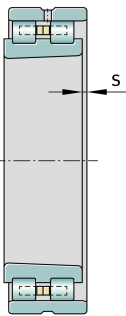
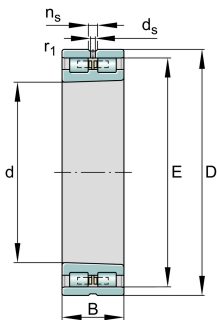

Your current product variant

Cage	M	Brass Cage
Tolerance class	SP	Tolerance class SP
Bore type	K	Tapered, taper 1:12
Change mark	A	Internal Variant A
Radial internal clearance	C1 (Group 1)	Internal clearance smaller than C2
Number of rows	2	Double-row design

Main Dimensions & Performance Data

d	480 mm	Bore diameter
D	700 mm	Outside diameter
B	165 mm	Width
C _r	2.700.000 N	Basic dynamic load rating, radial
C _{0r}	5.800.000 N	Basic static load rating, radial
C _{ur}	530.000 N	Fatigue load limit, radial
n _{G Grease}	1.070 1/min	Limiting speed for grease lubrication
n _{G Oil}	1.260 1/min	Limiting speed for oil lubrication
≈m	203,4 kg	Weight



Mounting dimensions

d_a	544 mm	Diameter shaft shoulder
	h12	Diameter shaft shoulder tolerance
D_a	656 mm	Diameter of housing shoulder
	H12	Shoulder diameter outer ring clearance
$r_{a1 \max}$	5 mm	Maximum recess radius





Dimensions

$r_{1 \min}$	6 mm	Minimum chamfer dimension
E	644 mm	Raceway diameter outer ring
n_s	23,5 mm	Width of lubricating groove
d_s	12,5 mm	Diameter lubrication hole
s	11,2 mm	Axial displacement

Temperature range

T_{\min}	-30 °C	Operating temperature min.
T_{\max}	150 °C	Operating temperature max.

Characteristics

	Radial load
	Grease Lubrication
	Oil Lubrication
	Not sealed
	Large bearing