

**FAG****NN3030-AS-K-M-SP**

Cylindrical roller bearing

Super precision cylindrical roller bearings
 NN30...-AS-K-M-SP, non-locating bearing,
 double row, with tapered bore, taper 1:12,
 separable, with cage

Technical information

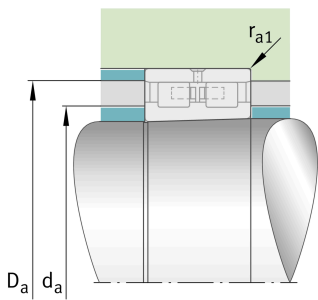
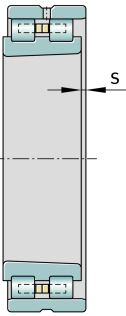

Your current product variant

Cage	M	Brass Cage
Tolerance class	SP	Tolerance class SP
Bore type	K	Tapered, taper 1:12
Change mark	A	Internal Variant A
Radial internal clearance	C1 (Group 1)	Internal clearance smaller than C2
Number of rows	2	Double-row design

Main Dimensions & Performance Data

d	150 mm	Bore diameter
D	225 mm	Outside diameter
B	56 mm	Width
C_r	335.000 N	Basic dynamic load rating, radial
C_{0r}	590.000 N	Basic static load rating, radial
C_{ur}	73.000 N	Fatigue load limit, radial
n_G Grease	3.650 1/min	Limiting speed for grease lubrication
n_G Oil	4.250 1/min	Limiting speed for oil lubrication
$\approx m$	7,92 kg	Weight



Mounting dimensions

d_a	172 mm	Diameter shaft shoulder
	h12	Diameter shaft shoulder tolerance
D_a	210 mm	Diameter of housing shoulder
	H12	Shoulder diameter outer ring clearance
$r_{a1 \max}$	2,1 mm	Maximum recess radius

Dimensions

$r_1 \min$	2,1 mm	Minimum chamfer dimension
E	206 mm	Raceway diameter outer ring
n_s	9,5 mm	Width of lubricating groove
d_s	4,8 mm	Diameter lubrication hole
s	3,8 mm	Axial displacement

Temperature range

T_{\min}	-30 °C	Operating temperature min.
T_{\max}	150 °C	Operating temperature max.

Characteristics

	Radial load
	Grease Lubrication
	Oil Lubrication
	Not sealed