

**GE140-UK-2TS**

Spherical plain bearing

Radial spherical plain bearing, maintenance-free, sliding layer: ELGOGLIDE, DIN ISO 12240-1, Tolerances of the outside diameter and bore not according to DIN ISO 12240-1, dimension series E, sealed

Technical information

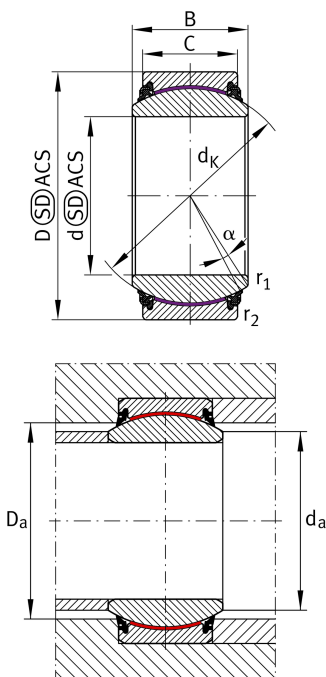

Your current product variant

Maintenance	Maintenance free	
Sealing	2TS	Integrated triple lip high performance seals on both sides
Bore lining	Without	
Coating	Without	
Fabric	ELGOGLIDE	
Material	Steel	

Main Dimensions & Performance Data

d	140 mm	Bore diameter bearing
C _r	3.020.000 N	Basic dynamic load rating, radial
D	210 mm	Outside diameter bearing
B	90 mm	Width inner ring
C	70 mm	Width Outer ring
C _{0r}	5.040.000 N	Basic static load rating, radial
≈m	11,12 kg	Weight

Mounting dimensions

r _{1smin}	1 mm	Edge Spacing
r _{2smin}	1 mm	Edge Spacing
D _{amin}	173 mm	Housing Connection Diameter
d _{amax}	155,9 mm	Connection measurement, inner ring









Dimensions

d_K	180 mm	Ball diameter
α	7 °	Tilt angle
D_{OT}	0 mm	Outside diameter, upper tolerance
D_{UT}	-0,03 mm	Outside diameter, lower tolerance
B_{OT}	0 mm	Width inner ring, upper tolerance
d_{UT}	-0,025 mm	Bore diameter bearing, lower tolerance
B_{UT}	-0,25 mm	Width inner ring, lower tolerance
d_{OT}	0 mm	Bore diameter bearing, upper tolerance
C_{OT}	0 mm	Width outer ring, upper tolerance
C_{UT}	-0,6 mm	Width outer ring, lower tolerance
G_r	0 - 0,085	Radial Clearance
G_{rmax}	0,085 mm	Radial clearance, maximum
G_{rmin}	0 mm	Radial clearance, minimum

Temperature range

T_{min}	-30 °C	Operating temperature min.
T_{max}	100 °C	Operating temperature max.

Characteristics

	Radial load
	Axial load in one direction
	Axial load in two directions
	Lifetime lubrication, freedom from maintenance
	Sealed on both sides
	Static angular error and misalignment
	Dynamic angular error and misalignment