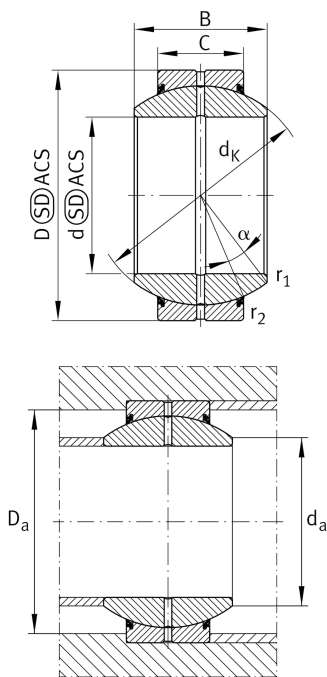

**GE15-FO-2RS-E**

Spherical plain bearing

Standard performance Radial spherical plain bearing, requiring maintenance, sliding contact surface: steel/steel, DIN ISO 12240-1, dimension series G, sealed

Technical information

**Your current product variant**

Maintenance	Maintenance required	
Material	Steel	
Sealing	2RS	Lip seals on both sides
Radial internal clearance	CN (Group N)	Normal internal clearance
Coating	Durotect M	Inner- and outer ring coated with Durotect M (Manganese Phosphate)

Main Dimensions & Performance Data

d	15 mm	Bore diameter bearing
D	30 mm	Outside diameter bearing
B	16 mm	Width inner ring
C _r	21.300 N	Basic dynamic load rating, radial
C _{0r}	106.000 N	Basic static load rating, radial
≈m	0,046 kg	Weight

Mounting dimensions

r _{1smin}	0,3 mm	Edge Spacing
r _{2smin}	0,3 mm	Edge Spacing
d _{a max}	19,2 mm	Connection measure Inner ring
D _{a min}	24 mm	Housing Connection Diameter



Dimensions







C	10 mm	Width Outer ring
d _K	25 mm	Ball diameter
α	16 °	Tilt angle
d _{OT}	0 mm	Bore diameter bearing, upper tolerance
d _{UT}	-0,008 mm	Bore diameter bearing, lower tolerance
d _T	0.008	Bore diameter bearing, tolerance
D _{OT}	0 mm	Outside diameter, upper tolerance
D _{UT}	-0,009 mm	Outside diameter, lower tolerance
B _{OT}	0 mm	Width inner ring, upper tolerance
B _{UT}	-0,12 mm	Width inner ring, lower tolerance
C _{OT}	0 mm	Width outer ring, upper tolerance
C _{UT}	-0,24 mm	Width outer ring, lower tolerance
G _r	0,04 - 0,082	Radial Clearance
G _{rmax}	0,082 mm	Radial clearance, maximum
G _{rmin}	0,04 mm	Radial clearance, minimum

Temperature range

T _{min}	-30 °C	Operating temperature min.
T _{max}	130 °C	Operating temperature max.



Characteristics

-  Radial load
-  Axial load in one direction
-  Axial load in two directions
-  Grease Lubrication
-  Sealed on both sides
-  Static angular error and misalignment
-  Dynamic angular error and misalignment