

**GE25-DO-E**

Spherical plain bearing

Standard performance Radial spherical plain bearing, requiring maintenance, sliding contact surface: steel/steel, DIN ISO 12240-1, dimension series E, open design

Technical information

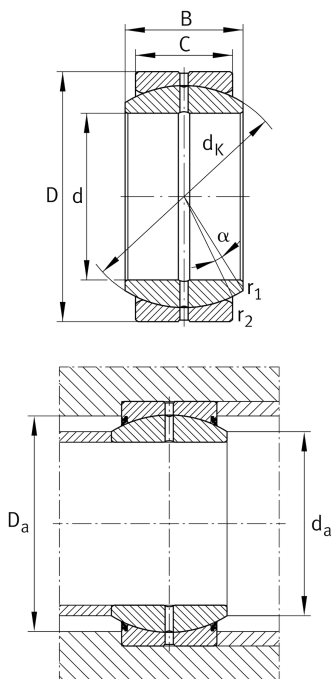

Your current product variant

Maintenance	Maintenance required	
Material	Steel	
Sealing	Without	
Radial internal clearance	CN (Group N)	Normal internal clearance
Coating	Durotect M	Inner- and outer ring coated with Durotect M (Manganese Phosphate)

Main Dimensions & Performance Data

d	25 mm	Bore diameter bearing
D	42 mm	Outside diameter bearing
B	20 mm	Width inner ring
C _r	48.300 N	Basic dynamic load rating, radial
C _{0r}	241.000 N	Basic static load rating, radial
≈m	0,11 kg	Weight

Mounting dimensions

r _{1smin}	0,6 mm	Edge Spacing
r _{2smin}	0,6 mm	Edge Spacing
d _{a max}	29,3 mm	Connection measure Inner ring
D _{a min}	33 mm	Housing Connection Diameter









Dimensions

C	16 mm	Width Outer ring
d_K	35,5 mm	Ball diameter
α	7 °	Tilt angle
d_{OT}	0 mm	Bore diameter bearing, upper tolerance
d_{UT}	-0,01 mm	Bore diameter bearing, lower tolerance
D_{OT}	0 mm	Outside diameter, upper tolerance
D_{UT}	-0,011 mm	Outside diameter, lower tolerance
B_{OT}	0 mm	Width inner ring, upper tolerance
B_{UT}	-0,12 mm	Width inner ring, lower tolerance
C_{OT}	0 mm	Width outer ring, upper tolerance
C_{UT}	-0,24 mm	Width outer ring, lower tolerance
G_r	0,05 - 0,1	Radial Clearance
G_{rmax}	0,1 mm	Radial clearance, maximum
G_{rmin}	0,05 mm	Radial clearance, minimum

Temperature range

T_{min}	-60 °C	Operating temperature min.
T_{max}	200 °C	Operating temperature max.

Characteristics

-  Radial load
-  Axial load in one direction
-  Axial load in two directions
-  Grease Lubrication
-  Sealed on both sides
-  Static angular error and misalignment
-  Dynamic angular error and misalignment